

T&J ELECTRIC (SINGAPORE) PTE LTD

Company Registration No: 200205797Z
10 Ubi Crescent, #02-24, Ubi Techpark, Singapore 408564
Telephone: +65 6547-4333 Fax: +65 6547-4666

Date: 11th June 2019

Subject: Product Info:

P8225S (15A 1-Gang Weatherproof Switched Socket)

Technical Data:

- Product Range: **Armor**
- Rated Voltage: 250VAC 50/60Hz
- Rated Current: 15A
- Dimension:
Top: 110 mm x 118 mm
Bottom: 110mm x 90mm
- Recommended wire size:
2.5 mm²~ 4.0mm²
- Ingress Protection: IP66
- Front cover can be padlocked
- Packing: 40 pcs/40 boxes/1 carton



Front View of P8225S



Bottom View of P8225S

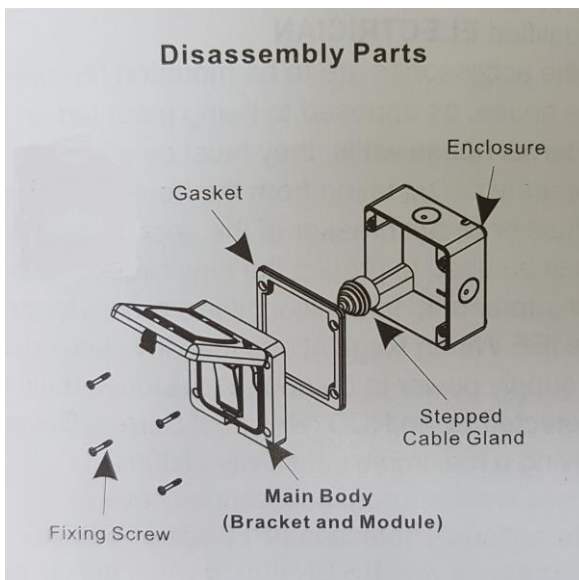

Enclosure removed