

T&J ELECTRIC (SINGAPORE) PTE LTD

Company Registration No: 200205797Z
10 Ubi Crescent, #02-24, Ubi Techpark, Singapore 408564
Telephone: +65 6547-4333 Fax: +65 6547-4666

Subject: Datasheet: Radiance - Telephone and Computer Socket

Features:

- 5mm Ultra Thin – streamlined contact surface.
- Made from premium quality polycarbonate and top grade PA66 Nylon. Fire and heat resistant, durable and shockproof.
- Choice of finish.

Telephone sockets:

- FCC68 RJ11 or RJ12
- BS 5733
- Terminal capacity: 1 per terminal
- Mounting Box: 16mm depth

4Core Telephone Socket

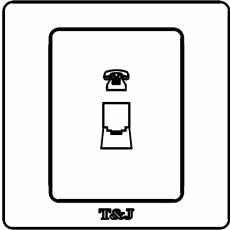

K801-4TU

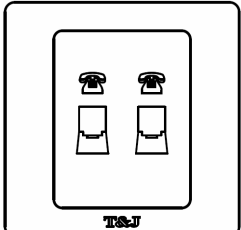

K802-4TU

Color code	
Terminal	Color
1	Yellow
2	Green
3	Red
4	Black

6Core Telephone Socket

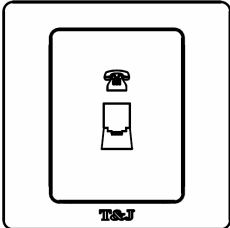

K801-6TU

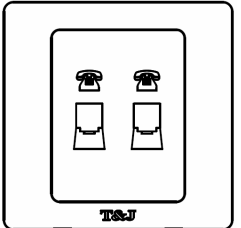

K802-6TU

Color code	
Terminal	Color
1	Grey
2	Yellow
3	Green
4	Red
5	Black
6	Blue

T&J ELECTRIC (SINGAPORE) PTE LTD

Company Registration No: 200205797Z
10 Ubi Crescent, #02-24, Ubi Techpark, Singapore 408564
Telephone: +65 6547-4333 Fax: +65 6547-4666

Subject: Datasheet: Radiance - Telephone and Computer Socket

Computer Sockets:

- RJ56 Jacks
- EIA/TIA 568A and 568B
- Both Cat 5e and Cat 6 are available.
- BS 5733
- Insertion tool is provided with computer socket.
- Computer socket and telephone can come together on a face plate.
- Terminal capacity: 1 per terminal
- Mounting Box: 32mm depth

Physical specification:

- Operating Temperature: -5°C to 40°C
- IP Rating: IP2X
- Dimensions: 86×86 mm
- Screw Fix Center: 60.3 mm
- Screw: M3.5 x 18 mm

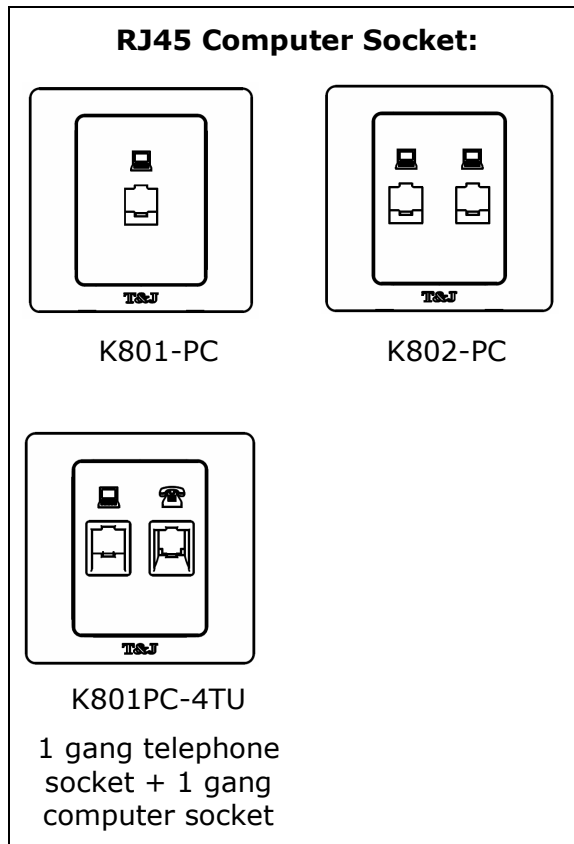

T&J ELECTRIC (SINGAPORE) PTE LTD

Company Registration No: 200205797Z
10 Ubi Crescent, #02-24, Ubi Techpark, Singapore 408564
Telephone: +65 6547-4333 Fax: +65 6547-4666

Subject: Datasheet: Radiance - Telephone and Computer Socket

Wiring Diagram:

K801-4TU

2 wire telephone circuit

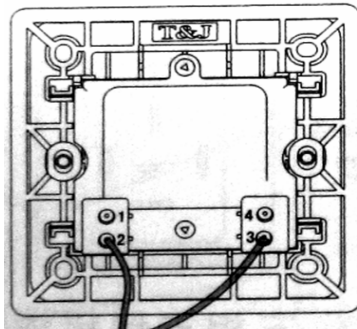

2 wire telephone circuit

4 wire telephone circuit

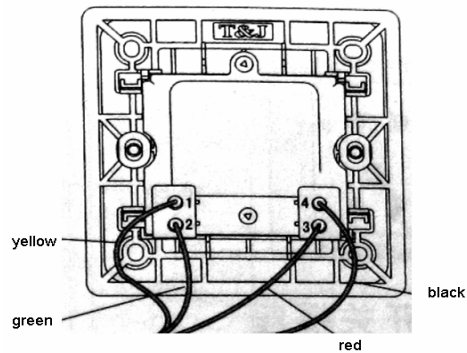

K801-6TU

2 wire telephone circuit

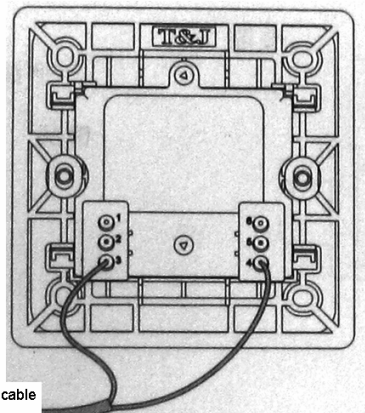

Telephone cable

6 wire telephone circuit

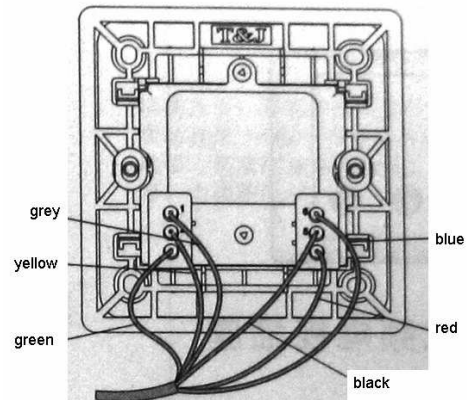

T&J ELECTRIC (SINGAPORE) PTE LTD

Company Registration No: 200205797Z
10 Ubi Crescent, #02-24, Ubi Techpark, Singapore 408564
Telephone: +65 6547-4333 Fax: +65 6547-4666

Subject: Datasheet: Radiance - Telephone and Computer Socket

Wiring Diagram:

K802-4TU or K801PC-4TU

2 wire telephone circuit

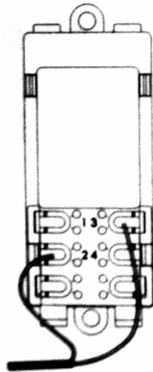

4 wire telephone circuit

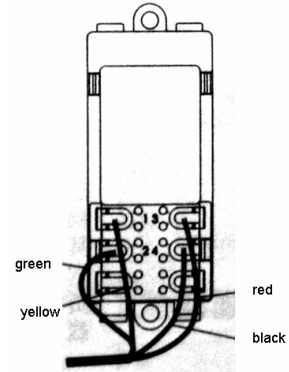

K802-6TU

2 wire telephone circuit

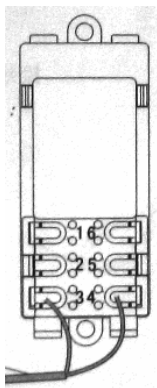

6 wire telephone circuit

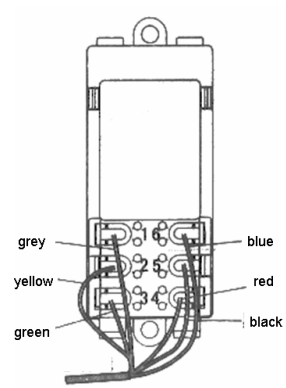

T&J ELECTRIC (SINGAPORE) PTE LTD

Company Registration No: 200205797Z
10 Ubi Crescent, #02-24, Ubi Techpark, Singapore 408564
Telephone: +65 6547-4333 Fax: +65 6547-4666

Subject: Datasheet: Radiance - Telephone and Computer Socket

Wiring Diagram:

K801-PC, K802-PC, K801PC-4TU

EIA/TIA 568A

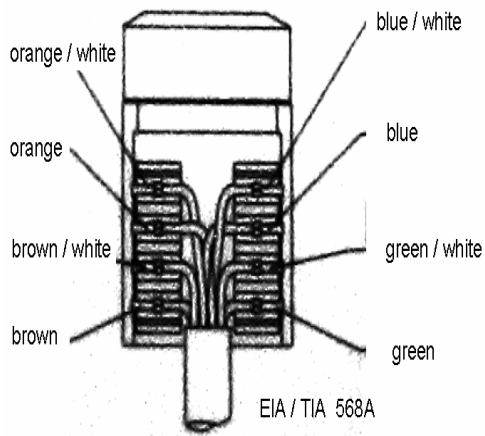

EIA/TIA 568B

